

Linear Solenoids

Frame Solenoids – Standard



Small Frame | Permanent Magnet

STSH-410

Type

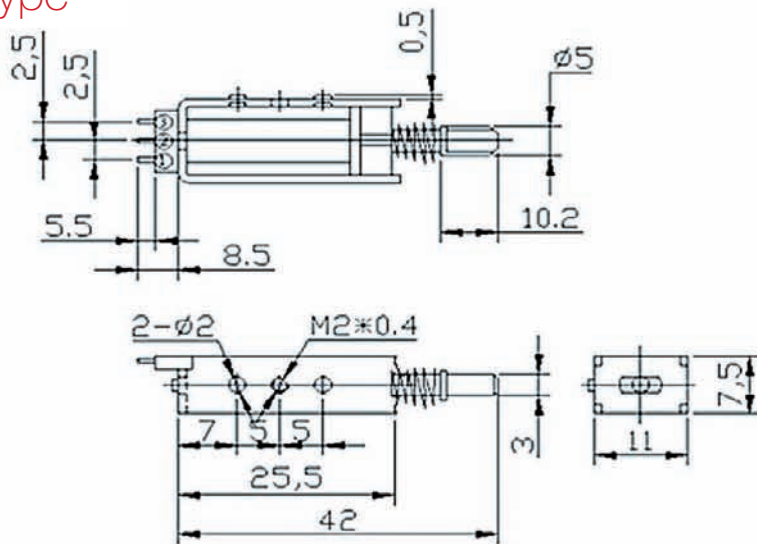

Force-stroke-diagram (N/mm)

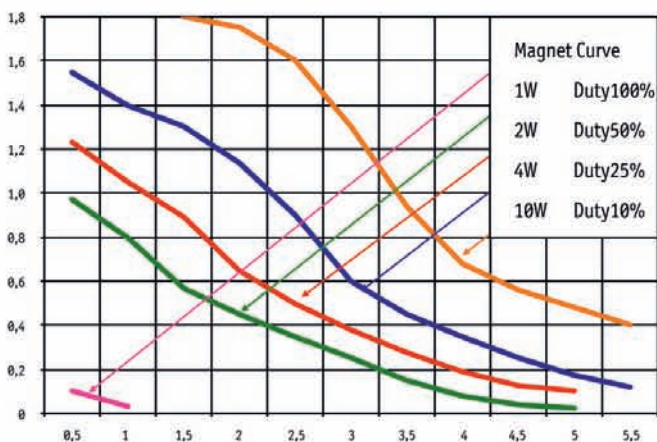

Description

A integrated permanent magnet is holding the plunger in position 0. To change into a bistable solenoid a spring is necessary.

Extremely small and powerful. Ideal to use with over-current.

Stroke: 4 mm

Holdingforce: 1 N. Weight: 10 g

Coil Data

Relative Duty Cycle (%)	100	50	25	10
Max. Performance (Watt)	1	2	4	10
Max. Duty Cycle (sec.)	∞	18	12	4

Solenoid Model

Version:

Pull magnet

Pressure Solenoid with spring return

Current:

12 VDC (standard)

24 VDC (standard)

Please ask for other options.

Special Development On Request

Please contact us for your custom designed part (frame, force, special application, etc.)



SHENG TENG GmbH
 VAT-ID: DE 271 696 661
 General Manager:
 Silvio Bruske / Frank Loeffler
 District Court Munich reg. # HRB185777

Angerbrunnenstraße 11
 D-85356 Freising
 GERMANY

Phone: +49-8161-986 44 84
 Fax: +49-8161-986 44 74
 eMail: office@shengteng.de

www.shengteng.de